

7 UHQFK 026 %DUULHU 6FKRWWN\ 5H

72 \$%
765 / &7

,72 \$%
765 / &7)

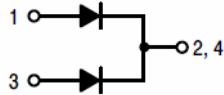
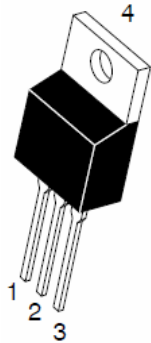

)HDXUHV

‡ \$GYDQWUHQFK WHFKQRORJ\
‡ /RZRUZDURGDWDJH GURS
‡ /RZRZURVVHV
‡ +LJKILFLHQF\ RSHUDWLRQ
‡ /HDGH)HLQLVK &RPSOLDQW

\$SSOLFDFWLRQV

‡ '& '& &RQYHUWHUV
‡ \$& '\$GDSWRUV
‡ 6ZLWFKRZHXSSOLHV
‡)UHHZKHHLRGLJ

0D[LPXP UDWLQJV DQG HOHFWULFDJ& FXODDWHVHUQRWHIGFV

3DUDPHWHU	6\PERO	/LPLW	8QLW
0D[LPXP SHSHVSHUNYHYURQHW DJH	9550		9
0D[LPXPYHURJHJZDUG UFXEWHHJWQ	GHYLFH ,) \$9 SHGLRGH		\$
3HDN IRVZDURSUHQW VLKDDHQH ZDYH VXSHULPSRVHGRFSGURVGHG	,)60		\$
2SHUDMXQRDQQRWRUDJH WHPSHUDW	XUH 0DQJH	WR	
7\SLFVQCHUPDO USHVULVQHDQFH	72 \$% ,72 \$%	5\$-&	f & : f & :
		7<3	0\$;

,QVWDQWDQHRRQRWRUDJH
SHGLRGH

9)

9

1RWHV
3XOVH WHVWSXOVH ZLGWK GXW\ F\FOH
3XOVH WHVW 3XOVH ZLGWK 0 PV

5 \$ 7 , 1 * 6 \$ 1 ' & + \$ 5 \$ & 7 (5 , 6 7 , & 6 & 7 5 9 (6 f & X Q O H V Q R W K B U Z L V H

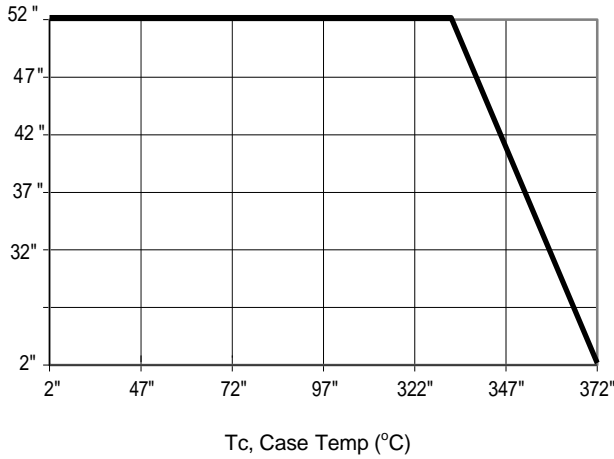

μ OE OE OE v šš •] v P U

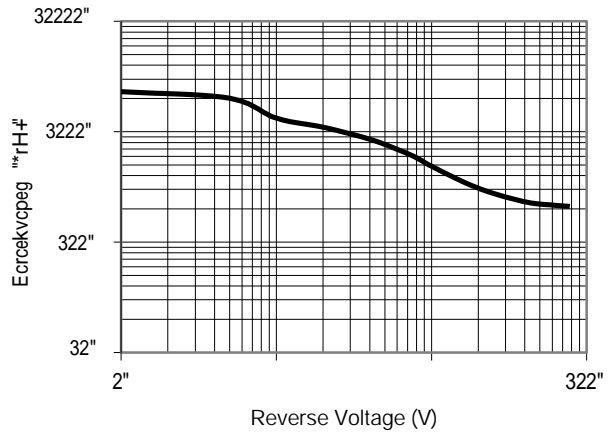

Typical Junction Capacitance

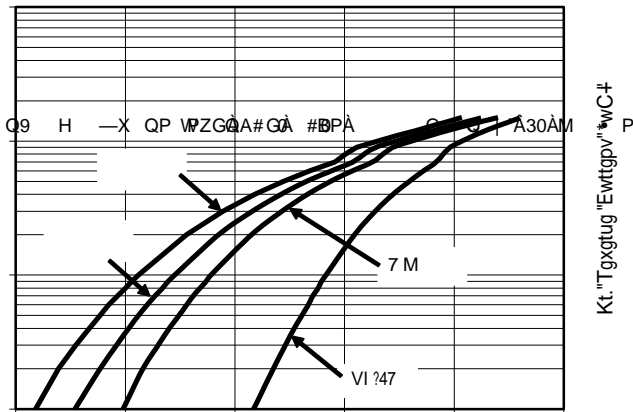

9I , Q V D V D B R X) R U D U G 9 R O W D J I R 9

Typical Forward Voltage

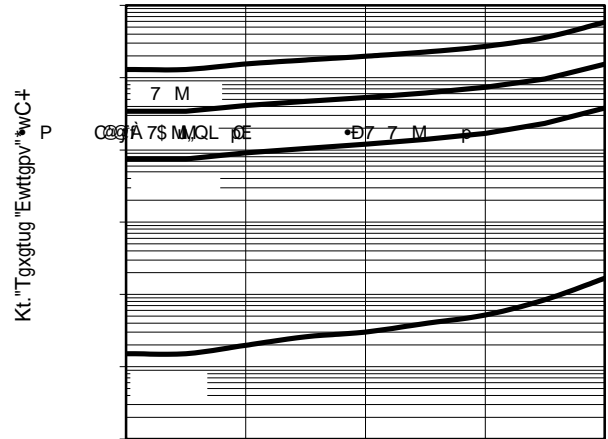

VR, Reverse Voltage (Volts)

d Ç %] À μ OE • OE v š

3 \$ & . \$ * (2 8 7 / , 1 (' , 0 (1 6 , 2 1 6

TO-220AB

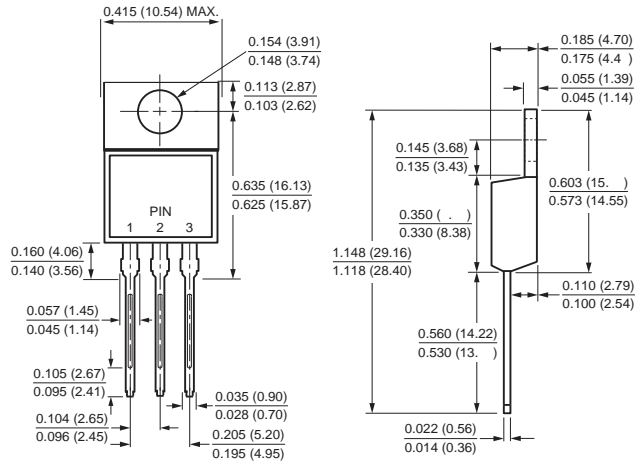

ITO-220AB

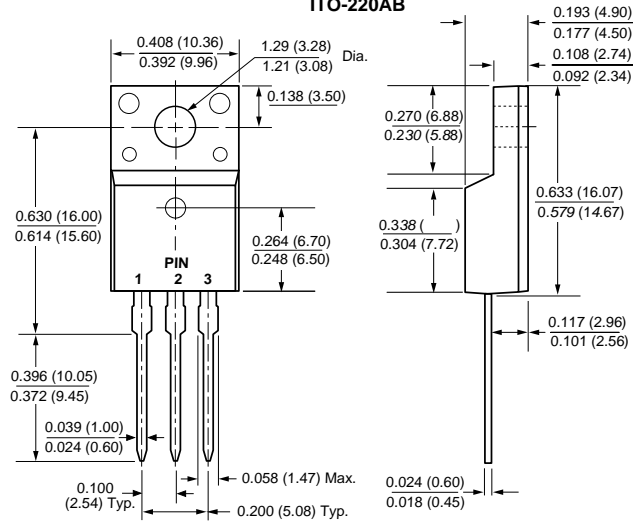

0DUNLQJ ,QIRUPDWLRQ

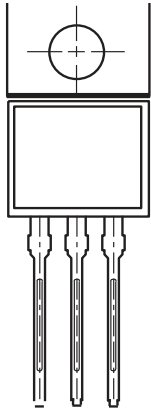

- ①
- ② 3URGXFW 765GH 7 RU 765 / &7)
- ③ 3' & LQIRUPDWLRQ

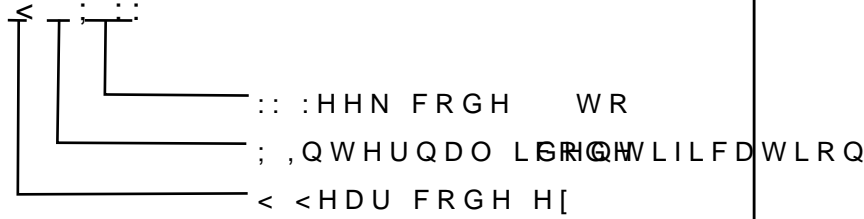

3DFNDJLQJ ,QIRUPDWLRQ

7XEH 'LPHQVLRQV

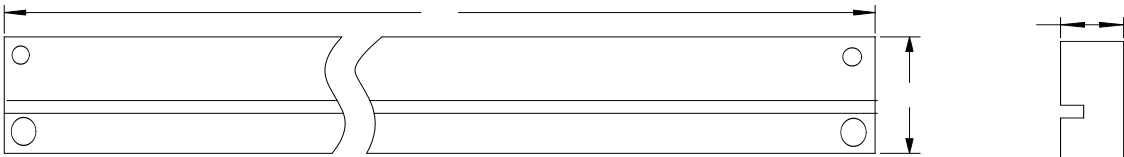

,QVLGH %R[

2XWVLGH %R[

3DFNDJLQJ ,QIRUPDWLRQ

12	81,	7XEH 'LPHQVLRQV			,QVLGH %R[2XWVLGH %R[
6L]H	PP	\$	%	& 100	&7	:	+	/	:	+
47<	3&6	3&6 7XEH			6PDOO 3DFWDJH3&6 WXEORWDO			3&6 FDUERGLW		
1RWH		7ROHUDQFH PP" PP			PP" PP			PP" PP		